

176079

μA709

HIGH-PERFORMANCE OPERATIONAL AMPLIFIER

FAIRCHILD LINEAR INTEGRATED CIRCUITS

GENERAL DESCRIPTION — The μA709 is a monolithic High Gain Operational Amplifier constructed using the Fairchild Planar* epitaxial process. It features low offset, high input impedance, large input common mode range, high output swing under load and low power consumption. The device displays exceptional temperature stability and will operate over a wide range of supply voltages with little performance degradation. The amplifier is intended for use in dc servo systems, high impedance analog computers, low level instrumentation applications and for the generation of special linear and nonlinear transfer functions.

ABSOLUTE MAXIMUM RATINGS

Supply Voltage	±18 V
Internal Power Dissipation (Note)	
Metal Can	500 mW
Mini DIP	310 mW
DIP	670 mW
Flatpak	570 mW
Differential Input Voltage	±5.0 V
Input Voltage	±10 V
Storage Temperature Range	
Metal, Hermetic DIP, and Flatpak	-65°C to +150°C
Molded DIP and Mini DIP	-55°C to +125°C
Operating Temperature Range	
Military (μA709A and μA709)	-55°C to +125°C
Commercial (μA709C)	0°C to +70°C
Pin Temperature	
Metal Can, Hermetic DIP, and Flatpak (Soldering 60 s)	300°C
Molded DIP and Mini DIP	260°C
Output Short-Circuit Duration	5 s

NOTE:
Rating applies to ambient temperature up to 70°C. Above 70°C ambient derate linearly at 6.3mW/°C for Metal Can, 8.3mW/°C for DIP, 7.1mW/°C for the Flatpak and 5.6mW/°C for the Mini DIP.

CONNECTION DIAGRAMS
8-PIN METAL CAN
(TOP VIEW)
PACKAGE OUTLINE 5S
PACKAGE CODE H

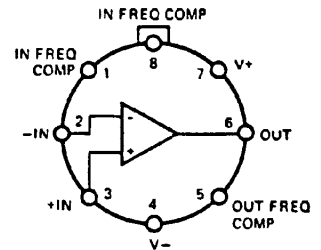

NOTE: Pin 4 connected to case

ORDER INFORMATION

TYPE	PART NO.
μA709A	μA709AHM
μA709	μA709HM
μA709C	μA709HC

CONNECTION DIAGRAMS

8-PIN MINI DIP
(TOP VIEW)
PACKAGE OUTLINE 9T
PACKAGE CODE T

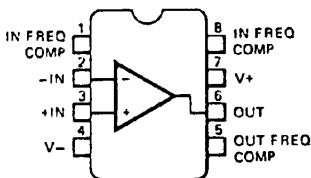

ORDER INFORMATION

TYPE	PART NO.
μA709C	μA709TC

10-PIN FLATPAK
(TOP VIEW)
PACKAGE OUTLINE 3F
PACKAGE CODE F

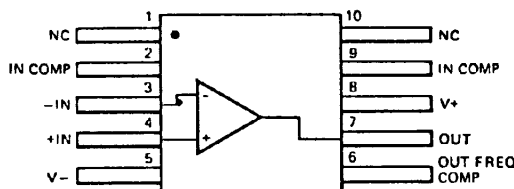

ORDER INFORMATION

TYPE	PART NO.
μA709A	μA709AFM
μA709	μA709FM

14-PIN DIP
(TOP VIEW)
PACKAGE OUTLINE 6A 9A
PACKAGE CODE D P

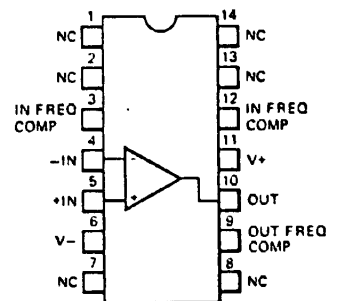

ORDER INFORMATION

TYPE	PART NO.
μA709A	μA709ADM
μA709	μA709DM
μA709C	μA709DC
μA709C	μA709PC

*Planar is a registered Fairchild process

FAIRCHILD • μ A709

μ A709A

ELECTRICAL CHARACTERISTICS: $T_A = +25^\circ\text{C}$, $\pm 9\text{ V} < V_S < \pm 15\text{ V}$ unless otherwise specified.

CHARACTERISTICS (see definitions)	CONDITIONS	MIN	TYP	MAX	UNITS
Input Offset Voltage	$R_S \leq 10\text{ k}\Omega$		0.6	2.0	mV
Input Offset Current			10	50	nA
Input Bias Current			100	200	nA
Input Resistance		350	700		k Ω
Output Resistance			150		Ω
Supply Current	$V_S = \pm 15\text{ V}$		2.5	3.6	mA
Power Consumption	$V_S = \pm 15\text{ V}$		75	108	mW
Transient Response	$V_S = \pm 15\text{ V}$, $V_{IN} = 20\text{ mV}$, $R_L = 2\text{ k}\Omega$, $C_1 = 5\text{ nF}$, $R_1 = 1.5\text{ k}\Omega$, $C_2 = 200\text{ pF}$, $R_2 = 50\Omega$ $C_L \leq 100\text{ pF}$			1.5	μs
		Overshoot			30

The following specifications apply for $-55^\circ\text{C} \leq T_A \leq +125^\circ\text{C}$:

Input Offset Voltage	$R_S \leq 10\text{ k}\Omega$			3.0	mV
Average Temperature Coefficient of Input Offset Voltage	$R_S = 50\Omega$, $T_A = +25^\circ\text{C}$ to $+125^\circ\text{C}$		1.8	10	$\mu\text{V}/^\circ\text{C}$
	$R_S = 50\Omega$, $T_A = +25^\circ\text{C}$ to -55°C		1.8	10	$\mu\text{V}/^\circ\text{C}$
	$R_S = 10\text{ k}\Omega$, $T_A = +25^\circ\text{C}$ to $+125^\circ\text{C}$		2.0	15	$\mu\text{V}/^\circ\text{C}$
	$R_S = 10\text{ k}\Omega$, $T_A = +25^\circ\text{C}$ to -55°C		4.8	25	$\mu\text{V}/^\circ\text{C}$
Input Offset Current	$T_A = +125^\circ\text{C}$		3.5	50	nA
	$T_A = -55^\circ\text{C}$		40	250	nA
Average Temperature Coefficient of Input Offset Current	$T_A = +25^\circ\text{C}$ to $+125^\circ\text{C}$		0.08	0.5	$\text{nA}/^\circ\text{C}$
	$T_A = +25^\circ\text{C}$ to -55°C		0.45	2.8	$\text{nA}/^\circ\text{C}$
Input Bias Current	$T_A = -55^\circ\text{C}$		300	600	nA
Input Resistance	$T_A = -55^\circ\text{C}$	85	170		k Ω
Input Voltage Range	$V_S = \pm 15\text{ V}$	± 8.0			V
Common Mode Rejection Ratio	$R_S \leq 10\text{ k}\Omega$	80	110		dB
Supply Voltage Rejection Ratio	$R_S \leq 10\text{ k}\Omega$		40	100	$\mu\text{V}/\text{V}$
Large Signal Voltage Gain	$V_S = \pm 15\text{ V}$, $R_L \geq 2\text{ k}\Omega$, $V_{OUT} = \pm 10\text{ V}$	25,000		70,000	V/V
Output Voltage Swing	$V_S = \pm 15\text{ V}$, $R_L \geq 10\text{ k}\Omega$	± 12	± 14		V
	$V_S = \pm 15\text{ V}$, $R_L \geq 2\text{ k}\Omega$	± 10	± 13		V
Supply Current	$T_A = +125^\circ\text{C}$, $V_S = \pm 15\text{ V}$		2.1	3.0	mA
	$T_A = -55^\circ\text{C}$, $V_S = \pm 15\text{ V}$		2.7	4.5	mA
Power Consumption	$T_A = +125^\circ\text{C}$, $V_S = \pm 15\text{ V}$		63	90	mW
	$T_A = -55^\circ\text{C}$, $V_S = \pm 15\text{ V}$		81	135	mW

PERFORMANCE CURVES FOR μ A709A

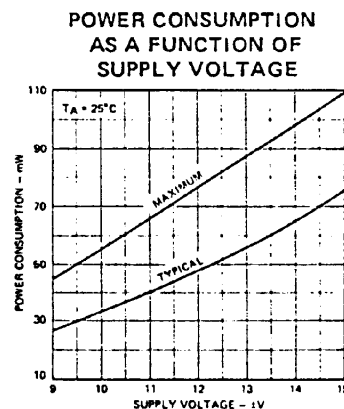
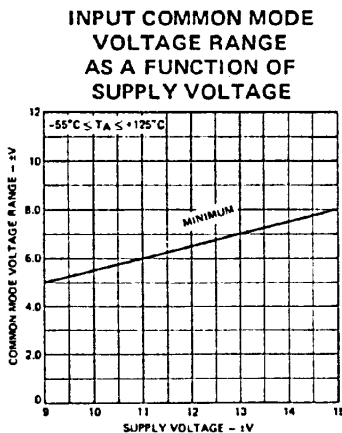
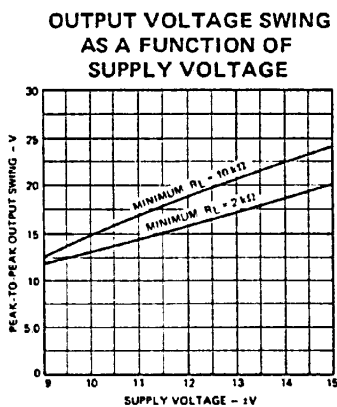
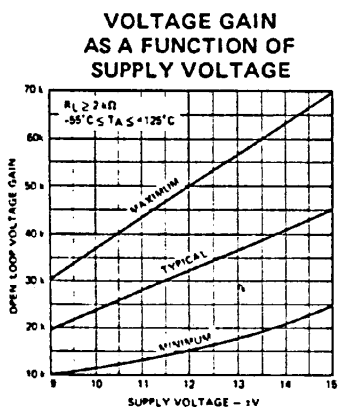

FAIRCHILD • $\mu A709$

$\mu A709$

ELECTRICAL CHARACTERISTICS: $T_A = +25^\circ C$, $\pm 9 V < V_S < \pm 15 V$ unless otherwise specified.

CHARACTERISTICS (see definitions)		CONDITIONS	MIN	TYP	MAX	UNITS
Input Offset Voltage		$R_S \leq 10 k\Omega$		1.0	5.0	mV
Input Offset Current				50	200	nA
Input Bias Current				200	500	nA
Input Resistance			150	400		$k\Omega$
Output Resistance				150		Ω
Power Consumption		$V_S = \pm 15 V$		80	165	mW
Transient Response	Rise time	$V_{IN} = 20 mV$, $R_L = 2 k\Omega$, $C_1 = 5000 pF$, $R_1 = 1.5 k\Omega$, $C_2 = 200 pF$, $R_2 = 50\Omega$		0.3	1.0	
	Overshoot	$C_L \leq 100 pF$		10	30	%

The following specifications apply for $-55^\circ C \leq T_A \leq +125^\circ C$:

Input Offset Voltage	$R_S \leq 10 k\Omega$			6.0	mV
Average Temperature Coefficient of Input Offset Voltage	$R_S = 50\Omega$			3.0	$\mu V/^\circ C$
	$R_S \leq 10 k\Omega$			6.0	$\mu V/^\circ C$
Large Signal Voltage Gain	$V_S = \pm 15 V$, $R_L \geq 2 k\Omega$, $V_{OUT} = \pm 10 V$	25,000	45,000	70,000	V/V
Output Voltage Swing	$V_S = \pm 15 V$, $R_L \geq 10 k\Omega$	± 12	± 14		V
	$V_S = \pm 15 V$, $R_L \geq 2 k\Omega$	± 10	± 13		V
Input Voltage Range	$V_S = \pm 15 V$	± 8.0	± 10		V
Common Mode Rejection Ratio	$R_S \leq 10 k\Omega$	70	90		dB
Supply Voltage Rejection Ratio	$R_S \leq 10 k\Omega$		25	150	$\mu V/V$
Input Offset Current	$T_A = +125^\circ C$		20	200	nA
	$T_A = -55^\circ C$		100	500	nA
Input Bias Current	$T_A = -55^\circ C$		0.5	1.5	μA
Input Resistance		40	100		$k\Omega$

PERFORMANCE CURVES FOR $\mu A709$

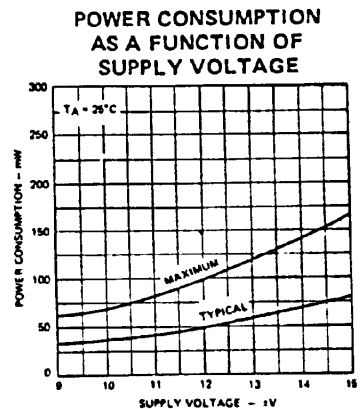
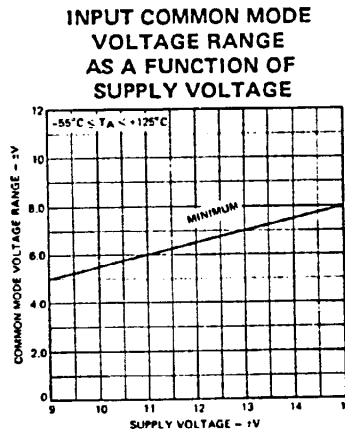
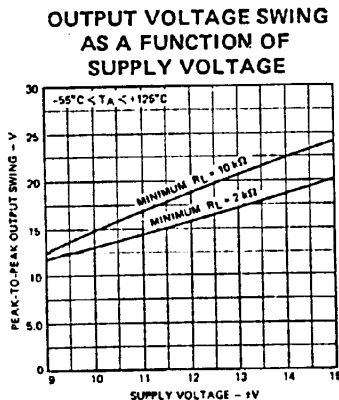
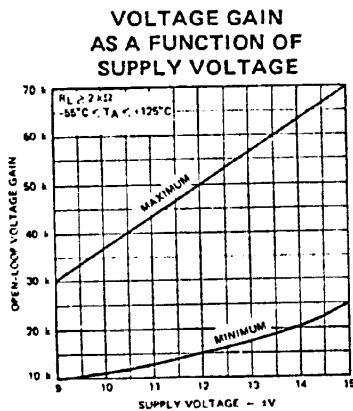

FAIRCHILD • μ A709

μ A709C

ELECTRICAL CHARACTERISTICS: $V_S = \pm 15$ V, $T_A = 25^\circ\text{C}$ unless otherwise specified.

CHARACTERISTICS (see definitions)		CONDITIONS	MIN	TYP	MAX	UNITS
Input Offset Voltage		$R_S \leq 10$ k Ω , ± 9 V $\leq V_S \leq \pm 15$ V		2.0	7.5	mV
Input Offset Current				100	500	nA
Input Bias Current				0.3	1.5	μ A
Input Resistance			50	250		k Ω
Output Resistance				150		Ω
Large Signal Voltage Gain		$R_L \geq 2$ k Ω , $V_{OUT} = \pm 10$ V	15,000	45,000		V/V
Output Voltage Swing		$R_L \geq 10$ k Ω	± 12	± 14		V
		$R_L \geq 2$ k Ω	± 10	± 13		V
Input Voltage Range			± 8.0	± 10		V
Common Mode Rejection Ratio		$R_S \leq 10$ k Ω	65	90		dB
Supply Voltage Rejection Ratio		$R_S \leq 10$ k Ω		25	200	μ V/V
Power Consumption				80	200	mW
Transient Response	Rise time	$V_{IN} = 20$ mV, $R_L = 2$ k Ω , $C_1 = 5000$ pF, $R_1 = 1.5$ k Ω , $C_2 = 200$ pF, $R_2 = 50\Omega$		0.3		μ s
	Overshoot	$C_L \leq 100$ pF		10		%

The following specifications apply for $0^\circ\text{C} \leq T_A \leq +70^\circ\text{C}$:

Input Offset Voltage		$R_S \leq 10$ k Ω , ± 9 V $\leq V_S \leq \pm 15$ V			10	mV
Input Offset Current					750	nA
Input Bias Current					2.0	μ A
Large Signal Voltage Gain		$R_L \geq 2$ k Ω , $V_{OUT} = \pm 10$ V	12,000			V/V
Input Resistance			35			k Ω

PERFORMANCE CURVES FOR μ A709C

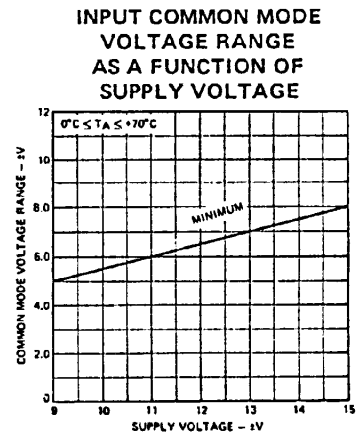
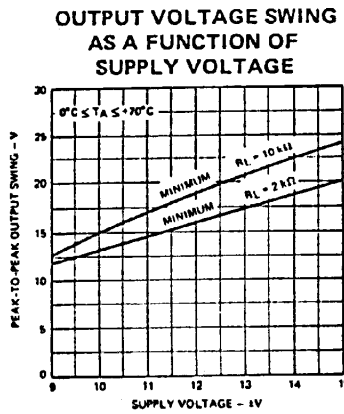
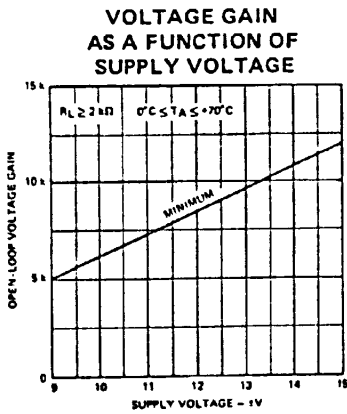

FREQUENCY COMPENSATION CURVES FOR ALL TYPES

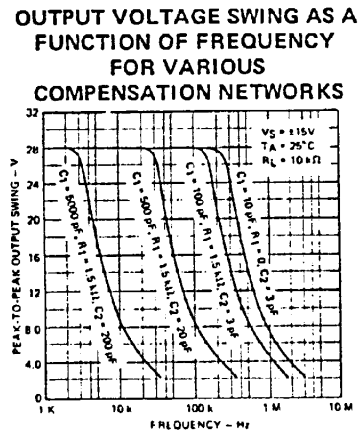
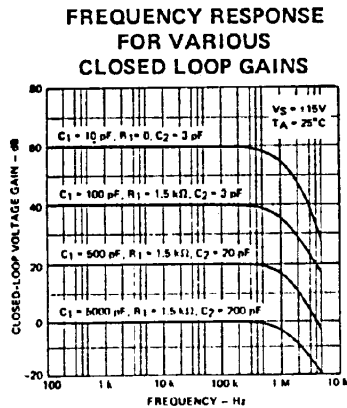
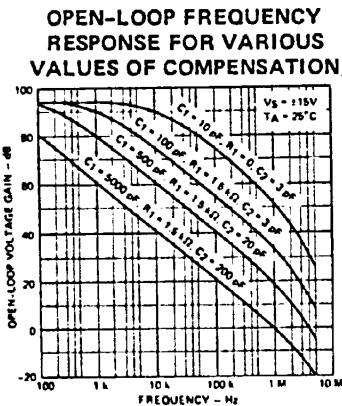

TYPICAL PERFORMANCE CURVES FOR $\mu A709A$

VOLTAGE TRANSFER CHARACTERISTIC

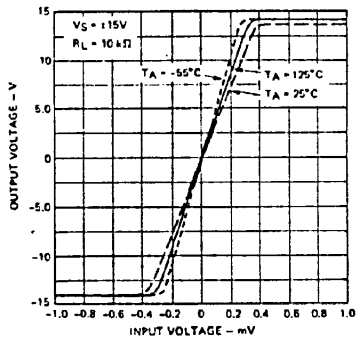

VOLTAGE GAIN AS A FUNCTION OF AMBIENT TEMPERATURE

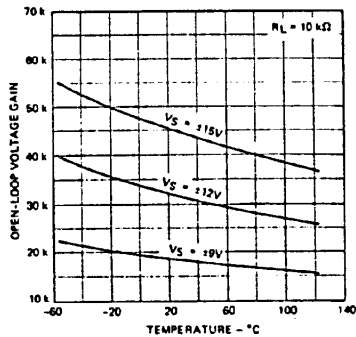

OUTPUT VOLTAGE SWING AS A FUNCTION OF LOAD RESISTANCE

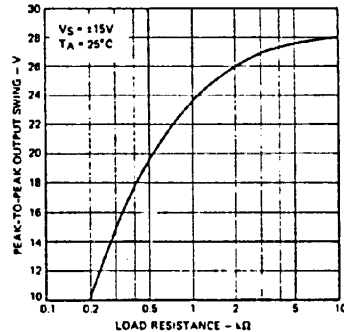

INPUT BIAS CURRENT AS A FUNCTION OF AMBIENT TEMPERATURE

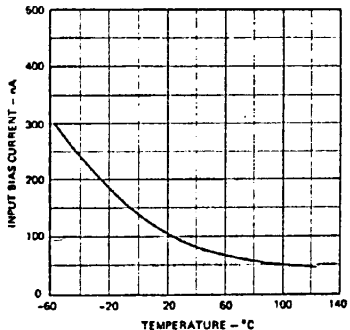

INPUT BIAS CURRENT AS A FUNCTION OF SUPPLY VOLTAGE

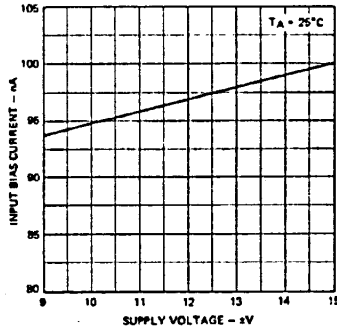

INPUT OFFSET CURRENT AS A FUNCTION OF AMBIENT TEMPERATURE

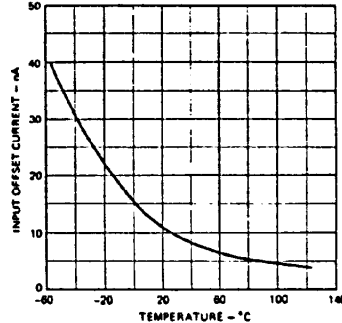

COMMON MODE REJECTION RATIO AS A FUNCTION OF AMBIENT TEMPERATURE

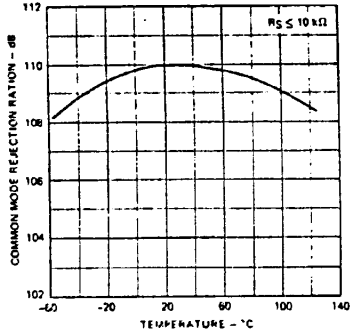

INPUT RESISTANCE AS A FUNCTION OF AMBIENT TEMPERATURE

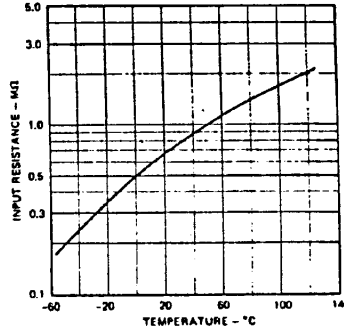

POWER CONSUMPTION AS A FUNCTION OF AMBIENT TEMPERATURE

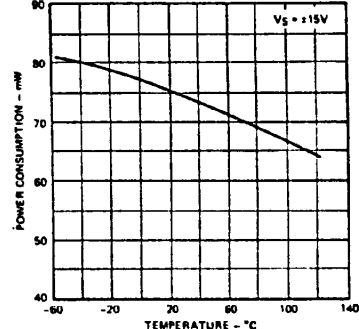

TRANSIENT RESPONSE

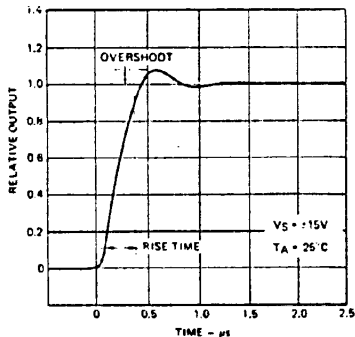

TRANSIENT RESPONSE TEST CIRCUIT

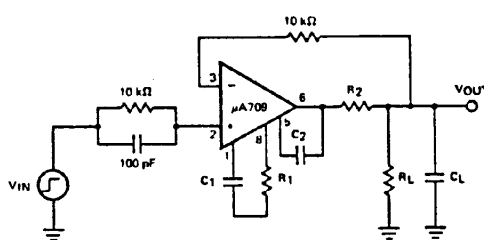

Pin numbers on this and all succeeding circuits apply to metal can or mini DIP package.

SLEW RATE AS A FUNCTION OF CLOSED-LOOP GAIN USING RECOMMENDED COMPENSATION NETWORKS

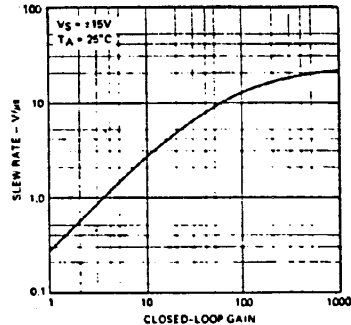

TYPICAL PERFORMANCE CURVES FOR $\mu A709$ AND $\mu A709C$

VOLTAGE TRANSFER CHARACTERISTIC

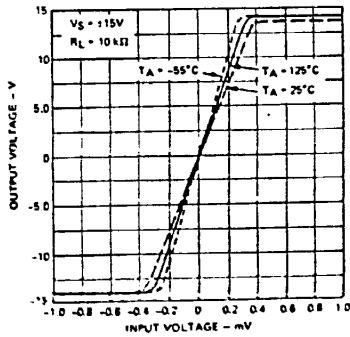

INPUT BIAS CURRENT AS A FUNCTION OF AMBIENT TEMPERATURE

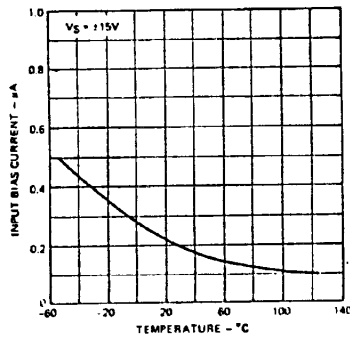

INPUT OFFSET CURRENT AS A FUNCTION OF AMBIENT TEMPERATURE

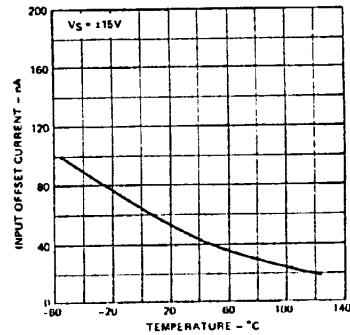

INPUT RESISTANCE AS A FUNCTION OF AMBIENT TEMPERATURE

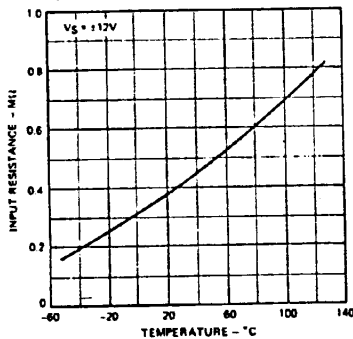

POWER CONSUMPTION AS A FUNCTION OF AMBIENT TEMPERATURE

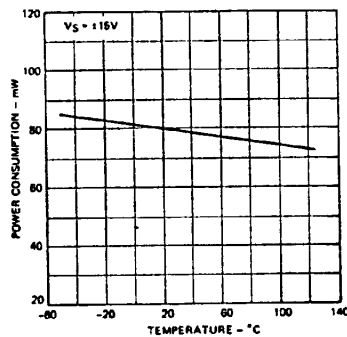

INPUT BIAS CURRENT AS A FUNCTION OF SUPPLY VOLTAGE

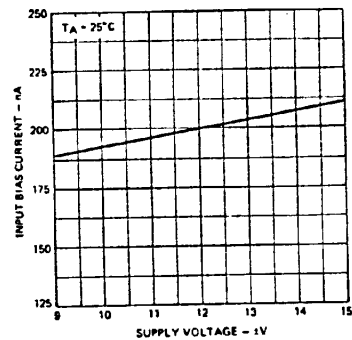

OUTPUT VOLTAGE SWING AS A FUNCTION OF LOAD RESISTANCE

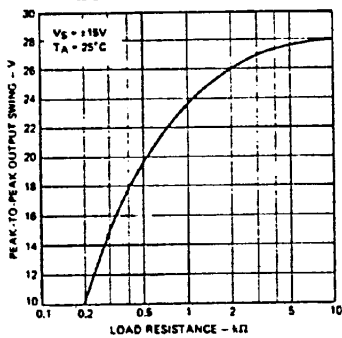

FREQUENCY COMPENSATION CIRCUIT

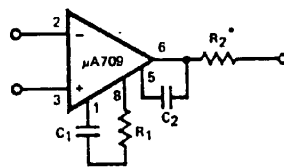

* Use $R_2 = 50 \Omega$ when the amplifier is operated with capacitive loading.

TRANSIENT RESPONSE

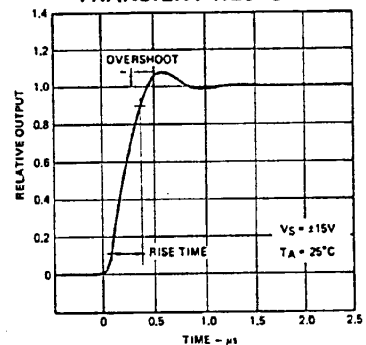

FREQUENCY CHARACTERISTICS AS A FUNCTION OF SUPPLY VOLTAGE

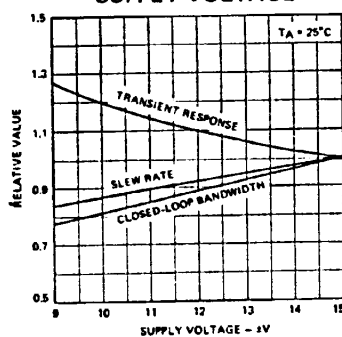

FREQUENCY CHARACTERISTICS AS A FUNCTION OF AMBIENT TEMPERATURE

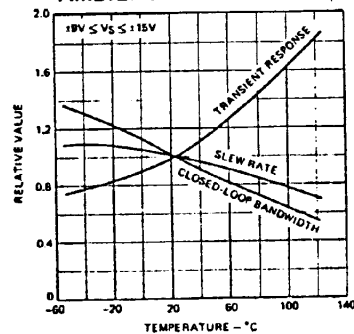

5

FAIRCHILD • μ A709

PROTECTION CIRCUITS

OUTPUT SHORT-CIRCUIT PROTECTION

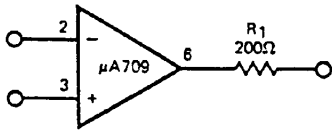

INPUT BREAKDOWN-PROTECTION

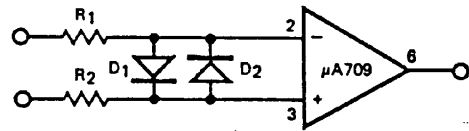

LATCH-UP PROTECTION

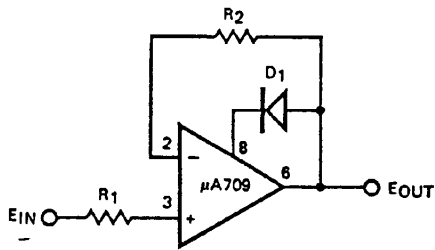

SUPPLY OVERVOLTAGE-PROTECTION

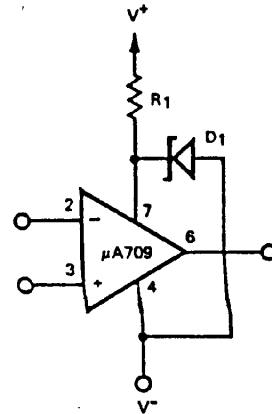

Pin numbers apply to metal can or mini DIP package only.

EQUIVALENT CIRCUIT

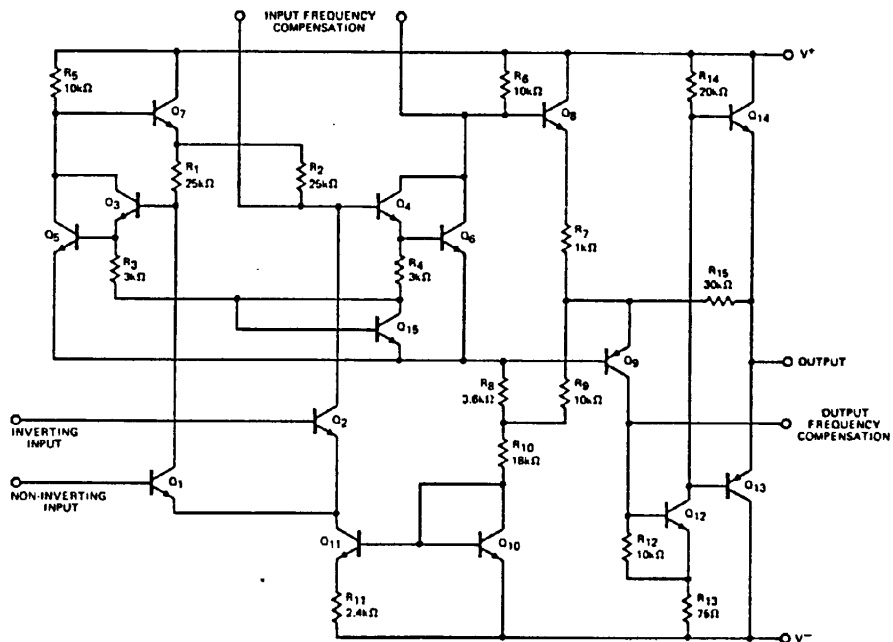

This datasheet has been downloaded from:

www.DatasheetCatalog.com

Datasheets for electronic components.