

## SECTION 4

### LINEAR AMPLIFIER AND SINGLE SIDEBAND SERVICE

#### 4.1 WHY SINGLE SIDEBAND

The increase in commercial and military communication traffic has become so great that a need exists for faster, more reliable, spectrum-conserving systems. **Single-sideband** (SSB) operation meets this need and makes more efficient use of the available spectrum.

The advantages of single-sideband transmission over conventional amplitude-modulated transmission have been discussed in literature<sup>12, 13, 14, 15</sup> and are summarized as follows:

1. The bandwidth requirement of the transmitted signal is less than half that of conventional double-sideband systems. For example, if a signal carrying the normal speech spectrum of 200 to 3000 Hz is transmitted via conventional amplitude-modulation-with-carrier systems the bandwidth required is twice the highest frequency being transmitted, or 6000 Hz. Elimination of the carrier and one sideband (neither of which is essential to the transmission of intelligence) permits the bandwidth to be reduced to 2800 Hz (Figure 43). The audio improvement in intelligence is enhanced because of the elimination of interfering audio heterodynes caused by adjacent channel signals.

---

12 J. F. Honey, "Performance of AM and SSB Communications," TeleTech. September, 1953.

13 Fundamentals of Single Sideband, Collins Radio Company, September, 1960.

14 E. W. Pappenfus, Warren B. Bruene, and E. O. Schoenike, Single Sideband Principles and Circuits, New York, McGraw-Hill, 1964.

15 Proceedings of the I.R.E. (Single Sideband Issue), December, 1956.



**Figure 43.** Relative spectrum space occupied by AM signal and SSB signal modulated by frequencies of 200 to 3000 Hz.

2. The narrower frequency band required for SSB operation allows bandwidth reduction of the selective circuits in the receiver to only that width needed to receive the signal without distortion. While there is some improvement in signal-to-noise ratio, the greatest improvement is the reduction in the strength (at the detector) of some of the interfering signals which would otherwise be admitted with the wider passband.
3. A relatively high level of information-bearing sideband power can be obtained without the use of a high-power modulator. This permits a lower average power in the final radio-frequency stage, and substantial reductions in total power input, total weight, and total cost of the transmitting equipment.
4. SSB operation greatly reduces the audio distortion often encountered over long-path transmissions using conventional amplitude-modulated signals.

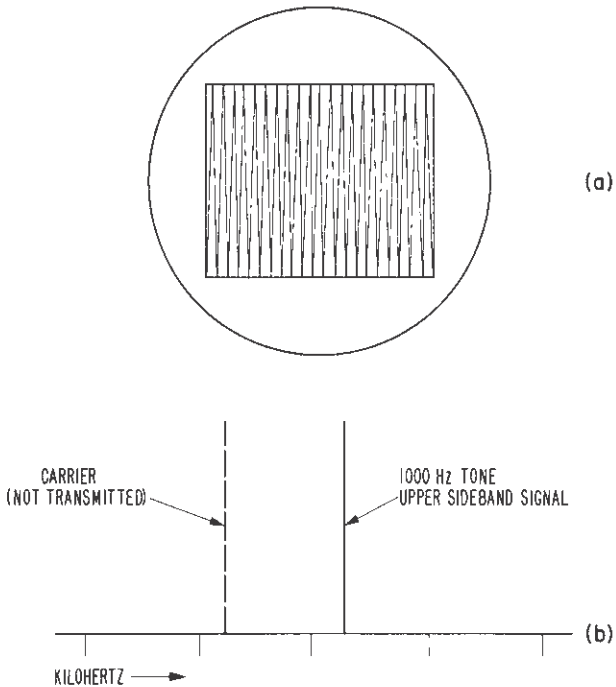
## **4.2 RATING TUBES FOR LINEAR AMPLIFIER SERVICE**

The power-handling capability of a given tube in single-sideband service depends upon the nature of the signal being transmitted and the power dissipating capability. In addition, the method of establishing single-sideband service ratings should be such that relatively simple test equipment can be used to determine whether or not a tube is operating within its maximum ratings.

It is impractical to establish a rating based on voice-signal modulation because of the irregular waveforms encountered and the varying ratios of peak-to-average signal power found in various voices. The most convenient rating method, and probably the most practical, employs a single-tone driving signal (such as

that from a sine-wave audio-signal generator) to modulate the SSB transmitter. By using this test signal at its full modulation capability, the amplifier will operate under steady, maximum-signal conditions which are easily duplicated and observed.

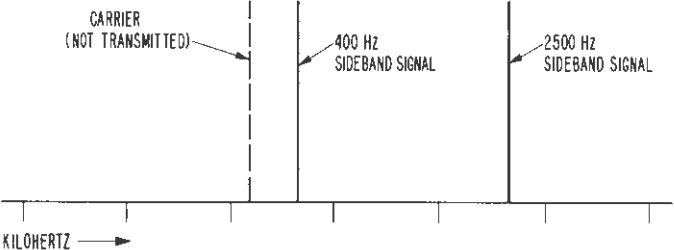
When a single sine-wave tone modulates a single-sideband transmitter, the RF output seen on an oscilloscope (Figure 44a) appears as a steady, unmodulated signal (resembling an unmodulated AM carrier) because the output is a continuous signal having a frequency removed from that of the carrier by the modulating frequency, as shown in Figure 44b.



**Figure 44. R-F output of SSB transmitter with single-tone modulation. (a) Oscilloscope pattern (b) Spectrum for 1000-Hz tone**

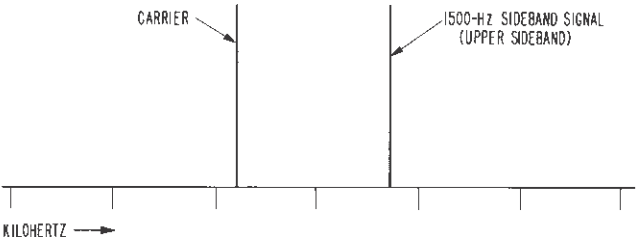
Consequently, the operation of a linear amplifier under single-tone modulation is comparable to that of a telegraph transmitter under key-down conditions. As such, the performance of the stage at maximum signal (or peak) conditions can be ascertained by meter readings. However, this simple test lacks information on the linearity of the stage. To study linearity thoroughly by observing the amplifier output, some means must be provided to vary the output

level from zero to maximum signal with a regular pattern that is easily interpreted. A simple means is to use two audio tones of equal amplitude to modulate the single-sideband transmitter. This is termed a **two-tone** test. This procedure causes the transmitter to emit two steady signals separated by the frequency difference of the two audio tones (Figure 45).

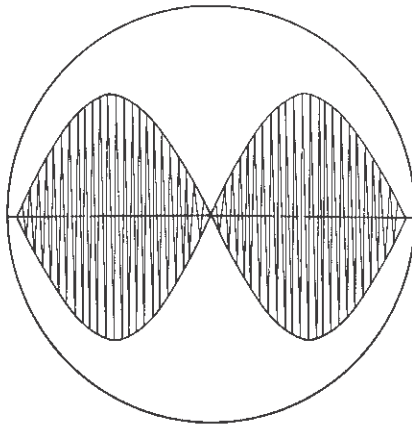


**Figure 45. Spectrum of SSB transmitter modulated by two-tone test signal containing 400- and 2500-Hz tones and transmitting upper sideband.**

In some single-sideband generators, this type of signal is obtained by impressing a single tone at the audio input and injecting the carrier (by unbalancing a balanced modulator) to provide the second equal amplitude RF signal (Figure 46). The resultant, or beat between the two RF signals, produces a pattern which, when observed on an oscilloscope, has the appearance of a carrier, 100 per cent amplitude modulated by a series of half sine waves as shown in Figure 47.



**Figure 46. Spectrum of SSB transmitter modulated by 1500-Hz tone and injecting carrier to obtain second RF signal equal in amplitude to tone.**



**Figure 47. R-f output of SSB transmitter modulated by two-tone test signal as seen on the oscilloscope.**

When measuring the distortion of a linear RF amplifier or a chain of linear RF amplifiers by the two-tone technique, it is sometimes more expedient to use two RF signal sources separated in frequency by the desired number of hertz, and then to combine them in a manner which will minimize the interaction of the two signals. The two RF signals represent the two equivalent sideband frequencies generated by the two audio-tone system and when viewed on an oscilloscope appear exactly the same.

A linear amplifier is usually rated at peak envelope input or output power level. **Peak envelope power (PEP)** is the root-mean-square (rms) power generated at the peak of the modulation envelope. With either a two-equal-tone test signal or a single-tone test signal, the following equations approximate the relationships between single-tone and two-tone meter readings, peak envelope power, and average power for Class B or Class AB operation.

#### 4.2.1 Single Tone

$$\text{DC Plate Current} \quad I_b = \frac{I_{pm}}{\pi} \quad (1)$$

$$\text{Plate Input Watts} \quad P_{in} = \frac{I_{pm} E_b}{\pi} \quad (2)$$

$$\text{Average Output Watts and PEP} \quad P_o = \frac{i_{pm} e_p}{4} \quad (3)$$

$$\text{Plate Efficiency} \quad \eta_p = \frac{\pi e_p}{4E_b} \quad (4)$$

#### 4.2.2 Two Equal Tones

$$\text{DC Plate Current} \quad I_b = \frac{2 i_{pm}}{\pi^2} \quad (5)$$

$$\text{Plate Input Watts} \quad P_{in} = \frac{2 i_{pm} E_b}{\pi^2} \quad (6)$$

$$\text{Average Output Watts} \quad P_o = \frac{i_{pm} e_p}{8} \quad (7)$$

$$\text{PEP Watts} \quad P_o = \frac{i_{pm} e_p}{4} \quad (8)$$

$$\text{Plate Efficiency} \quad \eta_p = \left(\frac{\pi}{4}\right)^2 \frac{e_p}{E_b} \quad (9)$$

#### 4.2.3 Definition of Symbols:

$i_{pm}$  = Peak of the plate current pulse—the plate current pulse is not sinusoidal.

$e_p$  = Peak value of plate swing, assumed to be sinusoidal when plate tank “Q” is sufficiently high.

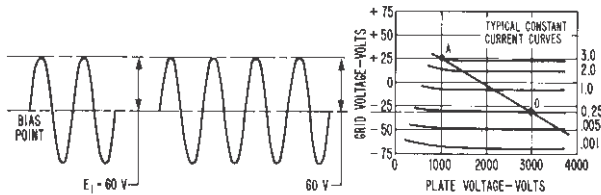
$\pi$  = 3.14

$E_b$  = d-c plate voltage

The approximate equations given above are for single-tone and two-tone conditions, the most common test situations. In some multi-channel transmitter applications, many more tones are used and the following method will determine the peak-envelope-power to average-power ratio. For the purposes of this explanation, it is assumed that all the tones are equal, however, unequal tones can be employed with this technique.

The following examples demonstrate two important relationships of single and multitone signals amplified by a linear system.

1. The amplifier is set up for a single-tone driving signal and a Point "A" (see Figure 48) on the operating line is established. A definite PEP output is developed under this condition. To drive this linear amplifier to the same PEP output with a multitone signal, the drive signal voltage for each tone must be  $1/n$ th ( $n$  = number of tones) the amplitude of the single-tone signal.
2. By assuming a perfectly linear amplifier wherein the input signal wave shape is exactly reproduced in the output load, these grid wave shapes can be used to demonstrate the relationship of PEP to Average Power.



**Figure 48. Single-tone condition.**

#### 4.2.4 Single-Tone Signal

$$P_{\text{avg}} = \frac{E_1(\text{rms})^2}{R_L} = \frac{\left(\frac{60}{\sqrt{2}}\right)^2}{R_L} = \frac{1800}{R_L} \text{ W} \quad (10)$$

$$\text{PEP} = \frac{E_1(\text{rms})^2}{R_L} = \frac{\left(\frac{60}{\sqrt{2}}\right)^2}{R_L} = \frac{1800}{R_L} \text{ W} \quad (11)$$

$$\text{Therefore, PEP} = P_{\text{avg}} \quad (12)$$

#### 4.2.5 Two-Tone Signal

$$\begin{aligned} P_{\text{avg}} &= P_{1 \text{ avg}} + P_{2 \text{ avg}} \quad (13) \\ &= \frac{(E_{1(\text{rms})})^2}{R_L} + \frac{(E_{2(\text{rms})})^2}{R_L} \\ &= \frac{\left(\frac{30}{\sqrt{2}}\right)^2}{R_L} + \frac{\left(\frac{30}{\sqrt{2}}\right)^2}{R_L} \\ &= \frac{450}{R_L} + \frac{450}{R_L} = \frac{900}{R_L} \text{ W} \end{aligned}$$

$$\begin{aligned}
 \text{PEP} &= \frac{(E_{1\text{rms}} + E_{2\text{rms}})^2}{R_L} & (14) \\
 &= \frac{\left(\frac{30}{\sqrt{2}} + \frac{30}{\sqrt{2}}\right)^2}{R_L} \\
 &= \frac{\left(\frac{60}{\sqrt{2}}\right)^2}{R_L} = \frac{1800}{R_L} \text{ W}
 \end{aligned}$$

$$\text{Therefore, PEP} = 2 \times P_{\text{avg}} \quad (15)$$

The two frequencies ( $f_1$  and  $f_2$ ) are equal in amplitude but slightly different in frequency. As a result, when they are exactly in phase, the two crest voltages add directly to produce the crest of the two-tone envelope. When the two frequencies are exactly out of phase, then the cusp of the two-tone envelope results (see Figure 49). Note that the voltage amplitude at the crest of the resultant two-tone envelope is equal to that of the single-tone envelope and therefore the tube is driven to the same point "A" on the operating line in each case. If the tube is driven to the same peak anode current and the same peak anode voltage swing by different exciting signals, then the Peak Envelope Power Output for both signals is the same.

#### 4.2.6 Three-Tone Signal

$$\begin{aligned}
 P_{\text{avg}} &= P_{1 \text{ avg}} + P_{2 \text{ avg}} + P_{3 \text{ avg}} & (16) \\
 &= \frac{(E_{1\text{rms}})^2}{R_L} + \frac{(E_{2\text{rms}})^2}{R_L} + \frac{(E_{3\text{rms}})^2}{R_L} \\
 &= \frac{\left(\frac{20}{\sqrt{2}}\right)^2}{R_L} + \frac{\left(\frac{20}{\sqrt{2}}\right)^2}{R_L} + \frac{\left(\frac{20}{\sqrt{2}}\right)^2}{R_L} \\
 &= \frac{200}{R_L} + \frac{200}{R_L} + \frac{200}{R_L} = \frac{600}{R_L} \text{ W}
 \end{aligned}$$

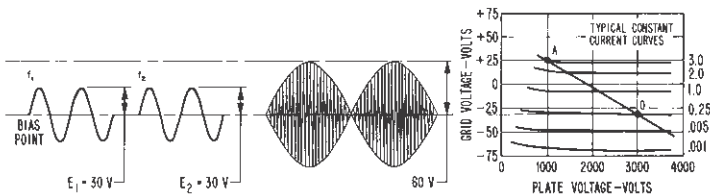


$$PEP = \frac{(E_{1rms} + E_{2rms} + E_{3rms})^2}{R_L} \quad (17)$$

$$= \frac{\left(\frac{20}{\sqrt{2}} + \frac{20}{\sqrt{2}} + \frac{20}{\sqrt{2}}\right)^2}{R_L}$$

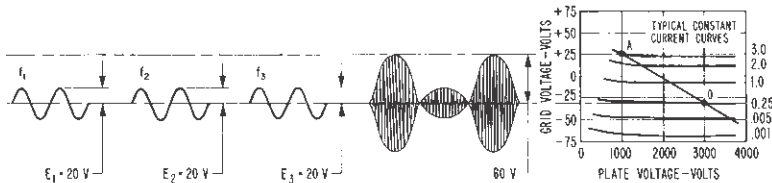
$$= \frac{\left(\frac{60}{\sqrt{2}}\right)^2}{R_L} = \frac{1800}{R_L} \text{ W}$$

Therefore,  $PEP = 3 \times P_{avg}$  (18)



**Figure 49. Two-tone condition.**

Note that the sum of the three individual tone crest exciting voltages add in phase to drive the tube to the same peak current and peak anode voltage swing as that of the single-tone case (see Figure 50). The PEP output will therefore be the same as for the single-tone and two-tone examples.



**Figure 50. Three-tone condition.**

The above results for equal amplitude tones may be summarized by the following expressions:

$$PEP = n P_{avg} \quad (19)$$

and  $PEP = n^2 \times P_t$  (20)

where  $P_{avg}$  = average power of composite signal

$P_t$  = average power in each tone

$n$  = number of tones

### **Example:**

**An FM mobile radiotelephone mountain-top repeater is to be designed to simultaneously rebroadcast one to eight channels. Each channel must have an average power output of 100 Watts. How much Peak Envelope Power must the linear amplifier deliver?**

Each channel can be considered to be a single-tone signal. Therefore, the PEP of each channel is equal to the average power of each channel. The maximum power output requirement of the amplifier will be under the 8-tone condition. The average power output for the composite 8-tone signal will be 8 times the 100 Watts-per-channel power. Therefore, the linear amplifier must be capable of 800 Watts of average power output. The Peak Envelope Power will be 8 times the average power of the composite signal ( $PEP = nP_{avg}$ ) or 6400 Watts. A tube must be selected to deliver this peak envelope and average power at an intermodulation distortion level compatible with the degree of inter-channel cross-talk that can be tolerated.

## **4.3 SELECTION OF TUBES FOR SINGLE SIDEBAND SERVICE**

As a guide in selecting tubes for various power levels of single-sideband service, typical operating conditions for various EIMAC tubes are included in this section. These data give values at the maximum signal condition for sustained singletone modulation, and also give the average current values (as read on a dc meter) using a two-tone test signal adjusted to the same peak envelope power as the single-tone condition. Voice-signal average currents will, of course, be lower than the two-tone condition by an amount depending upon the peak-to-average ratio of the voice signal, which is less than that of a two-tone signal in all cases. Typical third- and fifth-order intermodulation distortion product levels for maximum drive conditions are also given for the two-tone condition.

## GUIDE FOR SELECTION OF TUBES FOR SSB SERVICE

Tube Type	Plate Voltage Vdc	Screen Voltage Vdc	Suppressor Voltage Vdc	Bias Voltage Vdc	Filament Voltage V	Filament Current A	Zero Signal Plate Current mA	Single Tone Plate Current mA	Two Tone Plate Current mA	Useful PEP Output W	3rd Order Distortion Products dB	5th Order Distortion Products dB	Class of Service	Resonant Plate Load $\Omega$
3CX800A7	2200	—	—	8.2	13.5	1.5	15	500	313	750	-36	-32	AB2	2700
3CX1000A7	2500	—	—	0	5.0	3.3	270	800	560	1270	-32	-38	AB2	1650
3CX1500A7	3500	—	—	8.2	5.0	10.5	182	1000	675	2075	-38	-41	AB2	2000
3CX10,000A3	6000	—	—	-270	7.5	104	500	4000	—	8000	—	—	AB2	1020
	7000	—	—	-325	—	—	500	4000	—	20,000	—	—	AB2	1135
3CX10,000A7	7000	—	—	0	7.5	104	600	3720	—	17,700	—	—	AB2	1020
	7000	—	—	—	—	—	5000	5000	—	24,000	—	—	AB2	1745
4CX250B	2000	325	—	-56	6.0	2.9	90	277	196	348	-25	-25	AB1	4500
4CX250R	2000	400	—	-72	6.0	2.9	95	322	225	475	-25	-35	AB1	4000
4CX300A	2000	325	—	-56	6.0	3.9	90	277	196	348	-25	-25	AB1	4500
4CX300Y	2000	400	—	-72	6.0	3.9	100	312	222	423	-28	-30	AB1	3500
4CX350A	2200	300	—	-20	6.0	3.6	100	215	167	318	-29	-30	AB1	6000
4CX350F	2200	300	—	-20	26.5	0.81	100	215	167	318	-29	-30	AB1	6000
4CX600A	2000	400	—	-50	6.0	4.8	200	465	343	500	-30	-47	AB1	2000
	2500	300	—	-31	6.0	—	200	400	304	524	-32	-41	AB1	4100
4CX1000A/K	3000	310	—	-63	6.0	9.9	250	750	540	1400	-23	-26	AB1	2200
4CX1500B	2500	225	—	-34	6.0	9.9	300	720	530	890	-40	-47	AB2	1900
	2800	225	—	-34	6.0	9.9	300	755	555	1100	-41	-48	AB2	1900
	5000	850	—	-180	9.0	43.5	500	1660	1100	5300	-32	-35	AB1	1700
4CX5000A	5000	1000	—	-210	7.5	78	670	1670	1240	5260	-36	-36	AB1	1790
	7500	1250	—	-307	—	—	450	1900	1590	11,910	-24	-34	AB1	1580
4CX5000R	5000	1000	—	-197	7.5	78	800	2010	1480	5700	-35	-40	AB1	1450
	7500	1250	—	-300	—	—	500	1900	10,000	10,000	—	—	AB1	2460
4CX10,000D	7500	1350	—	-262	7.5	78	900	2300	1770	11,022	-35	-42	AB1	1600
	7500	1500	—	-340	—	—	500	3330	—	15,950	—	—	AB1	2250
4CX15,000A	7000	1250	—	-240	6.3	168	1500	3080	2380	11,300	-49	-45	AB1	1380
	10,000	1500	—	-370	—	—	1000	4250	—	28,500	—	—	AB1	1280
4CX40,000GM	10,000	1400	—	-169	15.0	170	2200	5530	—	50,000	-54	-52	AB1	780
5CX1500A	2500	500	0	-87	5.0	40	250	660	468	1090	-38	-39	AB1	2340
	3000	500	0	-88	—	—	250	690	482	1330	-36	-41	AB1	3000
	4000	500	0	-90	—	—	250	690	465	1785	-33	-42	AB1	4600
5CX3000A	4000	800	0	-142	9.0	43.5	500	1570	1100	3820	-40	-43	AB1	1550
	6000	700	0	-128	—	—	450	1340	950	4910	-39	-45	AB1	2825
	6000	800	-160	-157	—	—	450	1475	1029	5670	-40	-45	AB1	2350

The intermodulation distortion products will be as specified or better for all levels from zero-signal to maximum output power and are referenced against one tone of a two equal tone signal.

### 4.3.1 Intermodulation Distortion

In general, the criteria used in the selection of operating parameters for tubes in high-fidelity audio-amplifier service are applicable when selecting the operating conditions for linear RF amplifiers. In the case of the sideband linear amplifier, the degree of linearity of the stage is of considerable importance. Intermodulation distortion products in linear power-amplifier circuits can be caused by either amplitude gain nonlinearity or phase shift with change in input signal level. Intermodulation distortion products appear only when the RF signal has a varying envelope amplitude. A single continuous frequency wave will be amplified a fixed amount and shifted in phase a fixed amount. The nonlinearity of the amplifier will produce only harmonics of the input wave. If the input RF wave changes at an audio rate, however, the nonlinearity of the amplifier will cause undesirable intermodulation distortion products to appear. Previously, it was pointed out that a two-tone signal offers a convenient means of measuring distortion. If these two RF tones are equal in amplitude, the resultant signal envelope varies from zero to maximum, so that this signal can be used to test an amplifier over its entire dynamic amplitude range.

When an RF signal with varying amplitude is passed through a nonlinear device, many new products are produced. The frequency and amplitude of each component can be determined mathematically since the nonlinear device can be represented by a power series expanded about the zero-signal operating point. An excellent mathematical discussion of intermodulation distortion appears in "Single Sideband Principles and Circuits."

An example of a typical two-tone signal serves to summarize this mathematical presentation. Assume that two equal amplitude test signals ( $f_1 = 2.001$  MHz and  $f_2 = 2.003$  MHz) are applied to a linear amplifier. Figure 51 shows the output spectrum of the device.

Many of the distortion-product currents are seen to fall outside the passband of the amplifier tuned circuits. If no impedance exists at the frequencies of the distortion component, then no voltage can be developed. Further study of this spectrum discloses that no even-order products fall near the two desired signals. Some odd-order products, however, fall near the desired frequencies

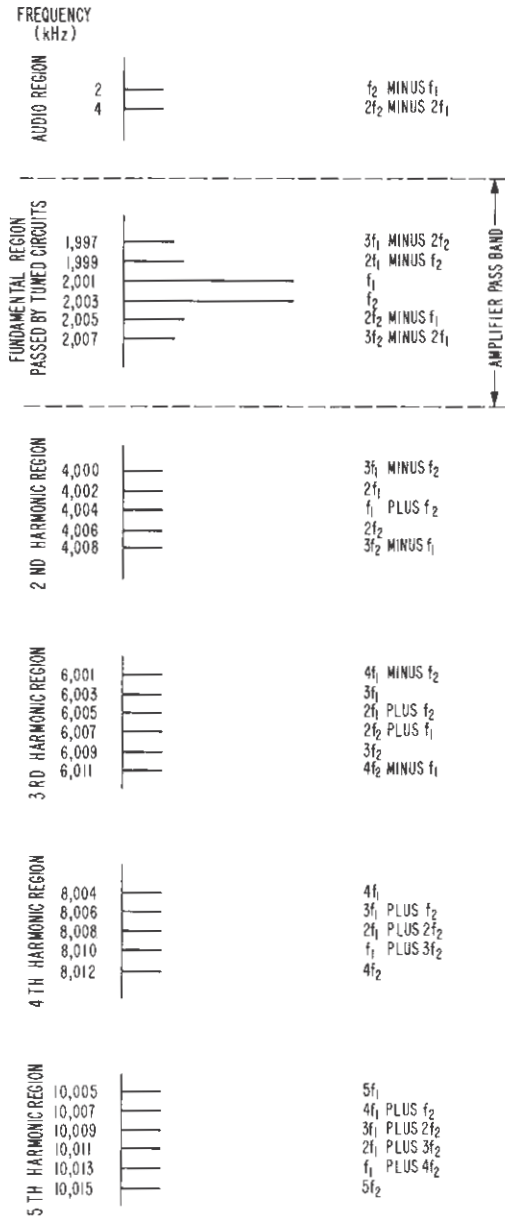


Figure 51. Spectrum at the output of a non-linear device with an input of two equal amplitude sine waves of  $f_1 = 2.001$  MHz and  $f_2 = 2.003$  MHz.

and possibly within the passband of the tuned circuits. The distortion products which are usually given in tube data sheets are the third- and fifth-order intermodulation-distortion products which can fall within the amplifier passband. Using the same  $f_1$  and  $f_2$  frequencies of the previous example, the frequencies of the third-order products are:

$$2f_1 - f_2 = 1.999 \text{ MHz}$$

$$2f_2 - f_1 = 2.005 \text{ MHz}$$

and the frequencies of the fifth-order products are:

$$3f_1 - 2f_2 = 1.997 \text{ MHz}$$

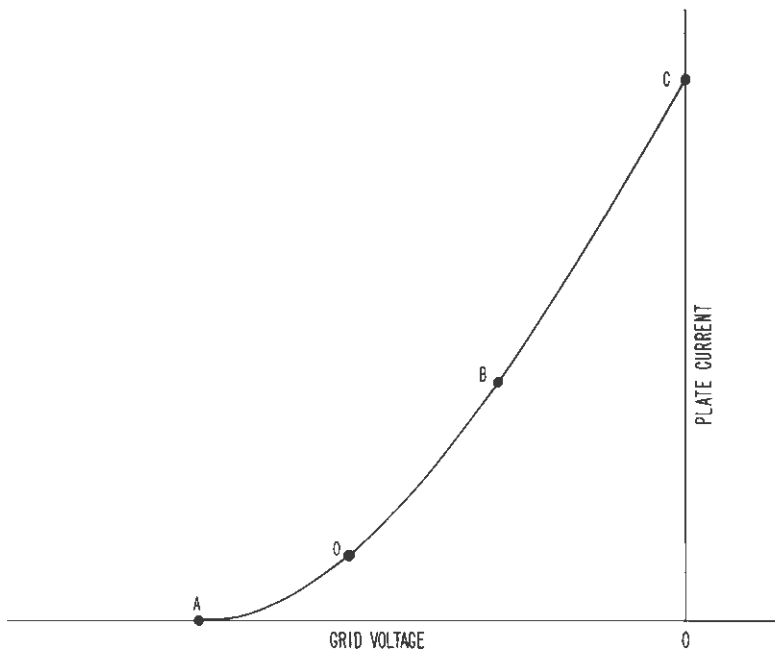
$$3f_2 - 2f_1 = 2.007 \text{ MHz}$$

These frequencies are well within the passband of a tuned circuit intended to pass voice frequencies and therefore power will be delivered to the antenna at these frequencies. **All intermodulation distortion power is wasted and serves no purpose other than to cause interference to adjacent channels.** The adjacent channels may be other services using nearby frequencies or other channels on the same transmitter. In any case, an interfering signal is created by the generation of distortion products in the (nearly) linear system.

#### 4.3.2 What Makes A Tube Linear?

Intermodulation distortion in a power amplifier tube is mainly caused by its transfer characteristics. An ideal transfer-characteristic curve is shown in Figure 52.

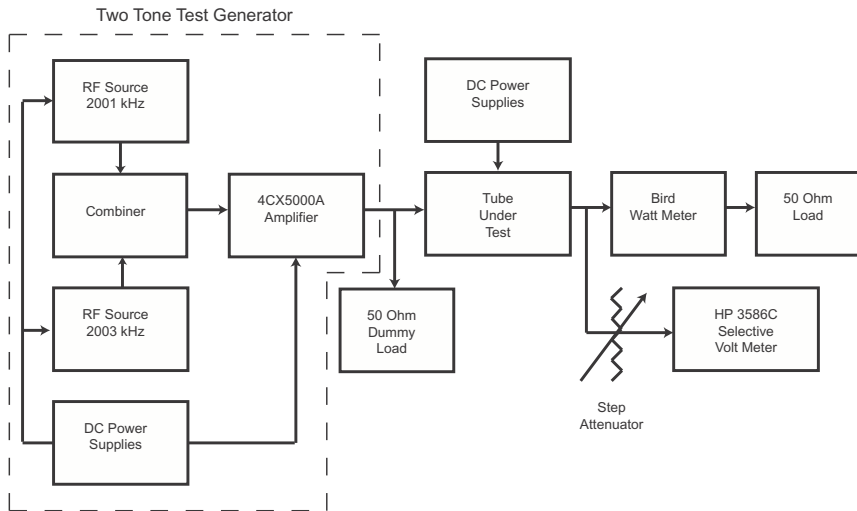
Even-order products do not contribute to the intermodulation distortion problem because they fall outside the amplifier passband. Therefore, if the transfer characteristic produces an even-order curvature at the small-signal end of the curve (from Point A to Point B) and the remaining portion of the curve (Point B to Point C) is linear, the tube is considered to have an ideal transfer characteristic. If the operating point of the amplifier is set at Point 0 (located midway horizontally between Point A and Point B), there will be no distortion in a Class AB amplifier. However, no tube has this idealized transfer characteristic. It is possible, by clever manipulation of the electron ballistics within a given tube structure, to alter the transfer characteristic and minimize the distortion products. Several tubes developed recently by EIMAC have transfer characteristics which significantly reduce intermodulation distortion.



**Figure 52. Ideal grid-anode transfer curve for Class AB operation.**

### 4.3.3 A Two Tone Intermodulation Distortion Test Analyzer

The Intermodulation Distortion Test Console at EIMAC uses two separate RF signal sources 2000 Hz apart. The two test signals are at 2.001 and 2.003 MHz. The signals are combined in a toroidal hybrid combiner and amplified by a 4CX5000A operating as a Class A amplifier. The 4CX5000A stage is loaded with a 50-ohm non-inductive load in addition to the impedance of the input circuit of the tube under test. The test amplifier can evaluate many different tube types and is capable of all classes of operation. It may be grid-driven or cathode-driven. See Figure 53 for a block diagram of an IMD test setup.



**Figure 53.** Block diagram of Intermodulation Distortion Analyzer. A low-distortion two-tone RF signal is generated at 2 MHz and applied to the test amplifier. The output of the amplifier is dissipated in a dummy load and a portion of the output signal is examined by a tunable voltmeter. Distortion products as low as -75 decibels below one tone of a two equal tone signal may be studied.

#### 4.3.4 Standards of Measurement

To adequately describe the performance of a tube in single sideband linear service, it is necessary to determine many parameters. The normal electrode voltages and currents must be specified plus the two-tone currents, the operating point, the peak envelope power (PEP), and the magnitude of the intermodulation-distortion products.

These parameters are defined as follows: The term **peak envelope power** is the root-mean-square power at the crest of the envelope.



This term is usually shortened to PEP.

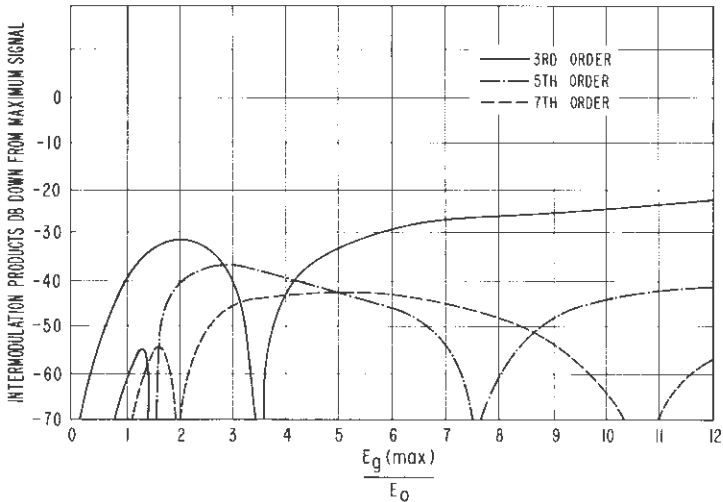
The idling anode current determined by the operating point is called the **zero-signal anode current** and is designated  $I_{b0}$ .

The other two anode current values of significance are the **single-tone anode current** and the **two-tone anode current**. The ratio of single-tone to two-tone current is 1.57:1 in a true Class B amplifier (180° anode conduction angle). For other classes of linear operation and for different zero-signal anode currents, this ratio may vary from 1.1:1 to 1.57:1.

**The standard method of specifying the magnitude of the distortion products is to specify the reduction in decibels of one product from one tone of a two-equal-tone signal.** For example:

Assume that a particular tube under a given set of operating conditions has third-order distortion products of -35 dB and fifth-order distortion products of -50 dB. This means the third-order product has an amplitude of 35 dB below one of the two test tones and the fifth-order product has an amplitude 50 dB below one of the two test tones. (It is also correct to add the amplitudes of the two third-order products and compare them to the **sum** of the two tones. The decibel ratio is still the same as the example.) It is **NOT** correct to compare one distortion product to the sum of the two tones; that is to say, the PEP value of the signal. The resulting distortion Figure would be 6 dB better than the correct example• (-41 dB rather than -35 dB and -56 dB rather than -50 dB).

It is a normal test procedure to adjust the tube under test to the full drive condition and to measure all the pertinent parameters. The drive signal is then reduced in a predetermined manner. At each test point, all of the previously noted parameters are again measured. The resulting data can then be plotted as a function of drive voltage. It should be noted that maximum intermodulation distortion does not necessarily occur at maximum drive level, and it can be shown mathematically that an intermodulation characteristic like Figure 54 can be expected. There is very good correlation between mathematical prediction and actual test results.



**Figure 54.** Intermodulation distortion products may be predicted mathematically. This universal family of IMD curves applies to all perfect tubes obeying the 3/2-power law. (See Section 6.4.) The curves are plots of IMD level (Y axis) referred to the driving signal expressed as a ratio of drive to operating bias. As the drive is increased, the various IMD products pass through maxima and minima. Misleading conclusions of amplifier performance may be drawn if the equipment happens to be tested near a cusp on the IMD curve, where a particular product drops to an extremely low level. The whole operating range of the equipment must be examined to draw a true picture of IMD performance.

#### 4.4 LINEAR AMPLIFIER DESIGN

The following features are desirable for tubes used in RF linear amplifier service, in addition to other elements discussed in Section 6, "Operating Conditions for Various Applications."

1. High power gain
2. Low anode-to-grid capacitance
3. Good efficiency
4. Linear characteristics which are maintained without degradation across the desired operating range.

For linear service, RF amplifiers may be operated in Class A, AB, AB<sub>2</sub>, or B modes. The choice of tube may be triode, tetrode, or pentode, either grid or cathode driven. The choice of mode, tube, and driving method will depend upon the operational specifications of each individual case.

#### 4.4.1 The Triode Amplifier

The triode tube having a large anode-to-grid interelectrode capacitance always requires neutralization in grid-driven service to prevent oscillation. A triode having a low amplification factor is suitable for Class AB<sub>1</sub>, and AB<sub>2</sub> grid-driven operation. The RF grid excitation voltage for this type of service will be quite high and grid excursions into the positive region are normal for Class AB<sub>2</sub> service. A swamping resistor should be used across the input tuned circuit to maintain a constant input impedance to the stage and for stability. With a low value of swamping resistance, the grid current drawn is only a small part of the total grid load and the driver load impedance is relatively constant. The swamping resistor improves RF stability by providing a low impedance to ground for regenerative feedback through the anode-to-grid capacitance.

The high-amplification-factor triode performs exceptionally well in circuits where the grid is grounded and the cathode is driven. Under these conditions, the control grid acts as a shield between the input and output circuits. Neutralization, therefore, is not normally required. EIMAC has developed a line of high amplification ("zero bias") triodes for cathode driven linear-amplifier service, producing stage gains of 10 decibels or more. These tubes operate in the Class AB<sub>2</sub> mode and require only filament, anode, and drive power. For optimum linear operation, a tuned circuit is placed in the cathode RF return path to maintain a sinusoidal wave shape over the drive cycle. The tuned circuit will reduce the intermodulation distortion produced by the amplifier and will also reduce drive power requirements.

The tuned-cathode circuit can be the output circuit of the previous stage if it is located close to the amplifier stage. If, however, the amplifier is far removed and coupled by a length of coaxial cable, it is recommended that a tuned cathode circuit with a "Q" of between two and four be used.

In all linear amplifier systems, the driver output impedance should be very low because of the nonlinear input loading characteristics of the amplifier tube as it approaches maximum power output. The lower the driver amplifier impedance, the smaller will be the effect of the nonlinear input loading.

#### 4.4.2 Effects of Idling Anode Current

The choice of the bias point for a linear amplifier used in single-sideband service is critical. The anode current at the zero-signal operating point is chosen for the best compromise between zero-signal anode dissipation and low intermodulation distortion. The bias point establishes the operating point on the tube transfer curve. The effect upon distortion of the operating point was discussed earlier in Section 4.3.2. Intermodulation distortion test data for the EIMAC 4CX1500B is shown in Figure 55. This illustration is a plot of intermodulation distortion and peak envelope output power as a function of zero-signal anode current ( $I_{b0}$ ). Typically, the zero-signal anode current for minimum distortion will produce about two thirds of the rated anode dissipation.

#### 4.4.3 Effects of Screen Voltage

Choice of screen voltage is a compromise between power output, zero-signal anode current, and intermodulation distortion. Usually, the lowest value of dc screen voltage compatible with a given power output will produce the lowest intermodulation distortion. Figures 55 and 56 show a comparison of the effects of screen voltage on distortion products for the EIMAC 4CX1500B.

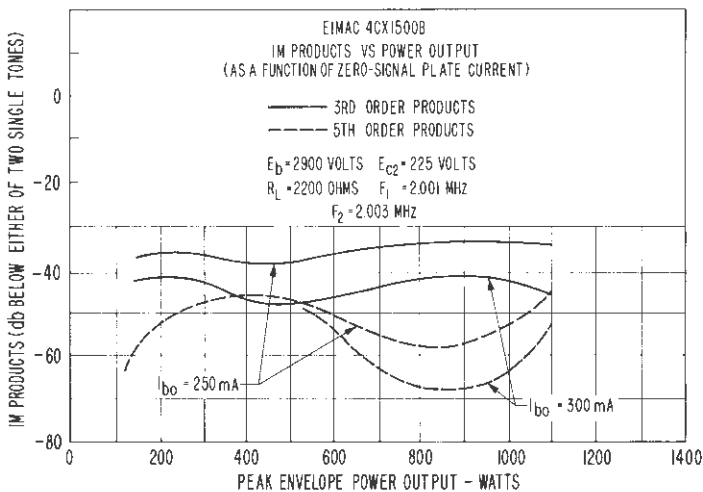
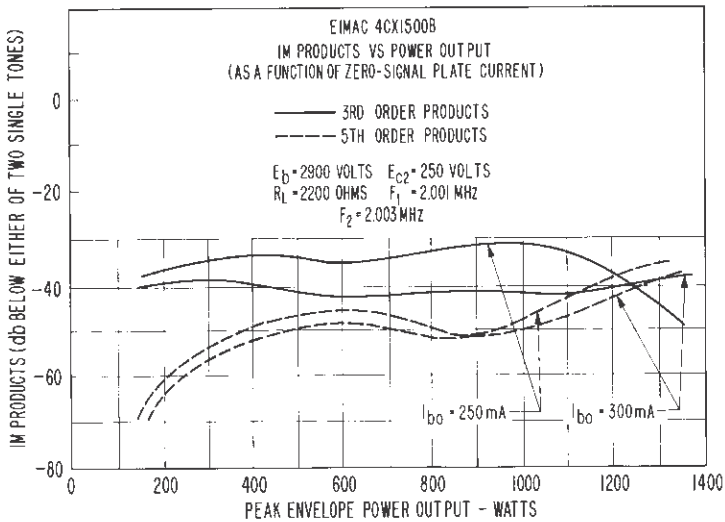


Figure 55. IM Distortion Test Data for EIMAC 4CX1500B ( $E_{C2} = 225V$ )



**Figure 56. IM Distortion Test Data for EIMAC 4CX1500B ( $E_{C2} = 250V$ )**

#### 4.4.4 Grid Driven Linear Amplifiers

The tetrode or pentode linear amplifier is usually grid driven in order to take advantage of the inherent high gain of the tube. A grid-driven amplifier can be driven into the grid current region under proper circumstances. In any case, the input circuit will be loaded by the tube grid. The no-grid current case will have the input conductance loading, while the grid-current case will have this degree of loading plus grid-current loading. It is therefore desirable (and necessary in the grid-current case) to swamp the input circuit with an appropriate non-inductive resistor. The resistor will maintain an almost constant load on the driver and minimize the effects of any nonlinearity in grid loading.

#### 4.4.5 Cathode Driven Linear Amplifiers

The cathode driven amplifier may use either triode, tetrode, or pentode tubes. The drive signal is applied to the cathode in this class of operation. This technique is often referred to as **grounded grid** since the control grid is usually at radio frequency ground. The cathode-driven amplifier is particularly suitable for high power stages using high- $\mu$  triodes in the HF and VHF region. This class of operation normally eliminates the need for neutralization, as the control grid screens the anode from the input circuit. The power

gain for suitable triode Class AB cathode-driven amplifiers is in the order of 7 to 20. The actual tube power gain is very nearly the ratio of radio frequency anode voltage to radio-frequency cathode voltage because the fundamental component of the anode current is common to the input and output circuits.

Tetrode tubes can be used in cathode-driven operation. Power gain is considerably higher than that of triodes, and is in the order of 20 to 50. It is important to recognize that screen-grid current loads the input circuit just as control-grid current does. It is necessary that control grid and screen grid voltages be applied to tetrodes to establish normal operating conditions. Dc grounded grids are not recommended for tetrodes in cathode driven service. Excessive grid dissipation will result if tetrodes are used without bias and screen voltages applied.

For an amplifier located some distance from the driver, an improvement in intermodulation distortion can be realized by tuning the cathode circuit. When the driver is located very close to the amplifier (1/10 wavelength, or so) other means may be used to minimize the nonlinear loading of the cathode driven stage.

#### 4.4.6 Tetrode and Pentode Amplifiers for Television Service

Most tetrode and pentode amplifiers are designed to be grid-driven to take advantage of the high power gain available, approx. 20 dB in most cases. An exception is RF power amplifiers used for analog television where broad bandwidth is required to pass the complex video signal. Depending on the type of amplifier (visual or visual plus aural) and what system is involved (NTSC, etc.) the amplifier must have a minimum power bandwidth of from 4.25 to 6 MHz (measured at 1 dB points) and minimum pulse-top ripple. This requires a low-Q tuned circuit (typically a Q of 1 or 2); the lower input capacitance of a cathode-driven tetrode as well as the lower impedance of this configuration helps improve bandwidth. The gain of a cathode-driven tetrode at VHF is typically 15 dB up to about 200 MHz.

Linearity in Class B is often adequate for visual service, although Class AB is used in most analog TV systems.

## 4.5 **ADJUSTING AND MONITORING THE LINEAR AMPLIFIER**

The individual tube data sheet includes all the necessary parameters required to make first approximation adjustments for optimum linearity. A spectrum analyzer or frequency tunable voltmeter, in conjunction with a two-tone drive signal, is necessary to make the final adjustments on a linear amplifier. The following procedures may be helpful in setting up a single-sideband linear amplifier and monitoring its operation:

The first step is to apply anode, screen, and suppressor voltages of the recommended values to the pentode linear amplifier and adjust the bias for the specified zero-signal anode current. Once this adjustment is made the operating point has been established.

The second step is to apply single-tone modulation to the amplifier. In a complete transmitter system which includes the audio amplifiers, sideband generator, and interstage amplifiers, the single tone may be obtained from an audio oscillator. For Class AB1 amplifiers, the drive should be increased until grid current **barely** starts to flow in the stage under test. Next the audio signal is reduced slightly until no current flows. For Class AB2 amplifiers, the drive should be increased until recommended grid current flows. It will be necessary to resonate the various tuned circuits before the drive is increased to full level. After the drive level has been fixed, the anode loading must be adjusted until recommended single-tone anode current flows (in the case of a triode), or until recommended screen current flows and is obtained (in the case of a tetrode or a pentode).

Note that the above procedure depends upon fixing the zero signal level point by adjusting the bias and the maximum-signal point with a single-tone test signal. This is an approximate procedure and is useful when only meters and a single-tone test signal are available. A two-tone test signal is required to make meaningful linearity measurements.

### 4.5.1 Adjustment With Two Tone Drive

Initial adjustments should be made with single-tone drive, as outlined in the previous paragraph, to obtain zero-signal and maximum-signal operating conditions. Once these conditions have been established, the amplifier is then driven with a two tone test signal **to the same peak grid voltage as that determined for**

**the single-tone case.** The anode current will be considerably less than for the single-tone condition. The ratio of single-tone to two-tone anode current varies between 1.1: 1 and 1.57:1. Adjustments in anode loading should not be made before the output of the amplifier has been sampled and observed on a panoramic analyzer or a tunable voltmeter. The actual intermodulation-distortion ratios may be measured and then grid drive and anode loading may be adjusted for minimum distortion compatible with the required peak envelope power output.

#### 4.5.2 Adjusting And Monitoring With Envelope Detectors

In addition to the above methods for adjusting the SSB linear amplifier at maximum-signal level with single-tone modulation and for obtaining optimum linearity with two-tone modulation, it may be convenient to use still another procedure<sup>16</sup> to make linearity adjustments and to provide a means of monitoring transmitted signals.

A pair of envelope detectors in conjunction with an oscilloscope can be employed to observe the linearity of an SSB amplifier regardless of the waveform of the modulating signal. Also, this technique affords instant observation of the effects of amplifier adjustments.

#### 4.5.3 Loading

The RF anode load of the tube in the linear amplifier has a great effect upon power output and linearity. Once the loading has been adjusted to provide the desired power output and distortion level, it is desirable to have a circuit in the transmitter to continually monitor the loading. A practical circuit should include a system for detecting the input RF voltage and the output RF voltage. Then, two detected signals are compared and displayed on a zero-center-scale meter or oscilloscope. With the correct ratio of output to input voltages, there will be no deflection of the meter. Under proper loading adjustment, this condition can be satisfied.

To achieve the proper resistive load to the tube, a method of tuning the anode circuit to the same frequency as the drive signal is required. Such systems have been devised making use of phase detectors. By comparing the phase of the anode voltage to that of the drive signal, one can tell when the anode circuit is resistive. This type of circuit is useful for continuous monitoring while the

---

<sup>16</sup> Pappenfus, et al, op. cit.



transmitter is in service. If the anode circuit is off-resonance, the anode load impedance will have a reactive component and hence will create an elliptical operating line. The elliptical operating line reduces efficiency and power output and distorts the linearity characteristic of the stage.

